

**From: SURFACTANTS IN SOLUTION, Vol. 6**  
Edited by K.L. Mittal and P. Bothorel  
(Plenum Publishing Corporation, 1986)

FORMULATION AND PROPERTIES OF AN ALCOHOL-FREE, PHARMACEUTICAL  
MICROEMULSION SYSTEM

K. A. Johnson and D. O. Shah

Center for Surface Science and Engineering  
University of Florida  
Gainesville, Florida 32611

An alcohol-free, water-in-oil microemulsion was formulated using two high molecular weight, pharmaceutically acceptable surfactants: sorbitan monolaurate (Arlacel 20 or Span 20) and sodium dioctyl sulfosuccinate (AOT). The amount of water solubilized depended on the oil chain length, the relative amounts of the two surfactants and the salinity of the water as well as the total surfactant weight. The optimal system contained equal weights of AOT and Arlacel 20 in hexadecane. With this system, one can obtain an isotropic dispersion containing equal volumes of oil and water with 21% total surfactants and no alcohol. With AOT and Arlacel 20 at a 1:1 weight ratio in hexadecane, the molecular ratio of water to total surfactant present was approximately 50. Addition of electrolytes drastically reduced water solubilization in the microemulsion system. Maximum water solubilization corresponded to a low interfacial tension between the oil and water. For a given oil chain length, a specific molar ratio of AOT to Arlacel 20 was required for maximum solubilization of water in the oil. Since the emulsifiers used are pharmaceutically acceptable, this microemulsion is promising for pharmaceutical and cosmetic applications.

INTRODUCTION

Microemulsions are thermodynamically or kinetically stable, isotropic, low viscosity dispersions consisting of microdomains of oil and/or water stabilized by an interfacial film of surface active molecules<sup>1</sup>. Such microemulsions contain domains with dimensions in the range of 10-100 nm and, hence, appear transparent like a single phase liquid. In general, microemulsions are prepared by mixing oil, water and an appropriate surfactant plus a cosurfactant that is usually a short chain alcohol<sup>2</sup>.

Typically, the surfactant used in formulating a microemulsion has a hydrocarbon chain length between 14 and 20 carbon atoms. In contrast, the alcohol chain length ranges from four to seven carbon atoms. This difference in chain length is required to produce a disordered and fluid interfacial film<sup>3</sup>.

Microemulsions have been used extensively in enhanced oil recovery processes<sup>4-8</sup>. Jayakrishnan, Kalaiarasi and Shah have shown that microemulsions are useful in pharmaceutical and cosmetic applications<sup>9</sup>. But, the alcohol present in these systems is not always acceptable for human use. Gillberg, Eriksson and Friberg have formulated alcohol-free, water-in-oil microemulsions in hexadecane, but the surfactants used were not acceptable in pharmaceutical preparations<sup>10</sup>. Therefore, the formulation of an alcohol-free pharmaceutical microemulsion is desirable. These alcohol-free microemulsions may also be useful for physicochemical studies where a short chain alcohol may not be desirable.

The strategy to formulate an alcohol-free microemulsion was to combine two high molecular weight surfactants with compatible polar groups (e.g. no charge repulsion or formation of complexes between the molecules) and dissimilar lipophilic groups in order to achieve the desired interfacial fluidity. AOT was selected as an anionic, branched chain surfactant to be blended with various pharmaceutically acceptable nonionic surfactants. The oil must have a low volatility to avoid an unpleasant odor; so, hexadecane was selected for this study.

## MATERIALS AND METHODS

Microemulsions were formulated by dissolving AOT plus a nonionic surfactant in oil and titrating this solution with distilled water or brine while stirring it with a Teflon coated magnetic bar. After each addition of water or brine, the solution was checked for clarity and then for birefringence using polarizing plates. The amount of water or brine that made the solution turbid and/or birefringent was the endpoint. Viscosity measurements were made using Cannon-Fenske viscometers (#100 and #150) in a constant temperature bath at 30°C. Interfacial tension measurements between oil/distilled water and oil/brine phases were made by the drop volume and drop height methods, respectively. The volumes of distilled water drops suspended at the tip of a glass syringe surrounded by a dilute solution of surfactants (0.3 weight %) in oil were measured with a Shardlow Metrology microsyringe. The height of brine drops on a Teflon plate in a 1% solution of surfactants in oil was measured with a Rame-Hart goniometer. A Centaur micropipette was used to place a 10 µl drop of brine on the plate. All measurements except for viscosity were performed at 25°C.

AOT was purchased from the American Cyanamid Co. and the nonionic surfactants were a gift from ICI Americas Inc. AOT is classified as a medicinal surfactant and is used internally (10 to 60 mg/day) as a wetting agent<sup>11</sup>. Skin irritation data were not available for AOT at the concentrations used in this microemulsion. At lower concentrations, AOT was shown to be minimally irritating to the skin and irritating to the eyes<sup>12</sup>. Undiluted Arlacel 20 is classified as nonirritating to the eyes and skin<sup>13,14</sup>. For internal use, Arlacel 20 is considered nontoxic by government standards<sup>15</sup>. All oils (99% pure) were purchased from Fisher Scientific Co.

## RESULTS AND DISCUSSION

Table I presents the results of the screening experiment where AOT plus an equal amount of a nonionic surfactant were mixed in hexadecane and the maximum amount of water solubilized was determined. The highest water to oil volume ratio was for the mixture of AOT and Arlacel 20. Figure 1 is

Table I. Effect of Cosurfactant on Solubilization of Water in Microemulsions with Hexadecane as the Oil and AOT as the Surfactant. Initial Concentrations of Surfactant and Cosurfactant in Hexadecane Were Each 20% (w/v).

Cosurfactant	HLB	Maximum Water to Oil Ratio (v/v)
Brij 96	12.4	0.171
Tween 81	10.0	0.248
Brij 30	9.7	0.324
Tween 61	9.6	0.281
Arlatone T	9.0	0.190
Arlacel 20	8.6	0.875
Brij 52	5.3	0.092
Brij 93	4.9	0.112
Arlacel C	3.7	0.180

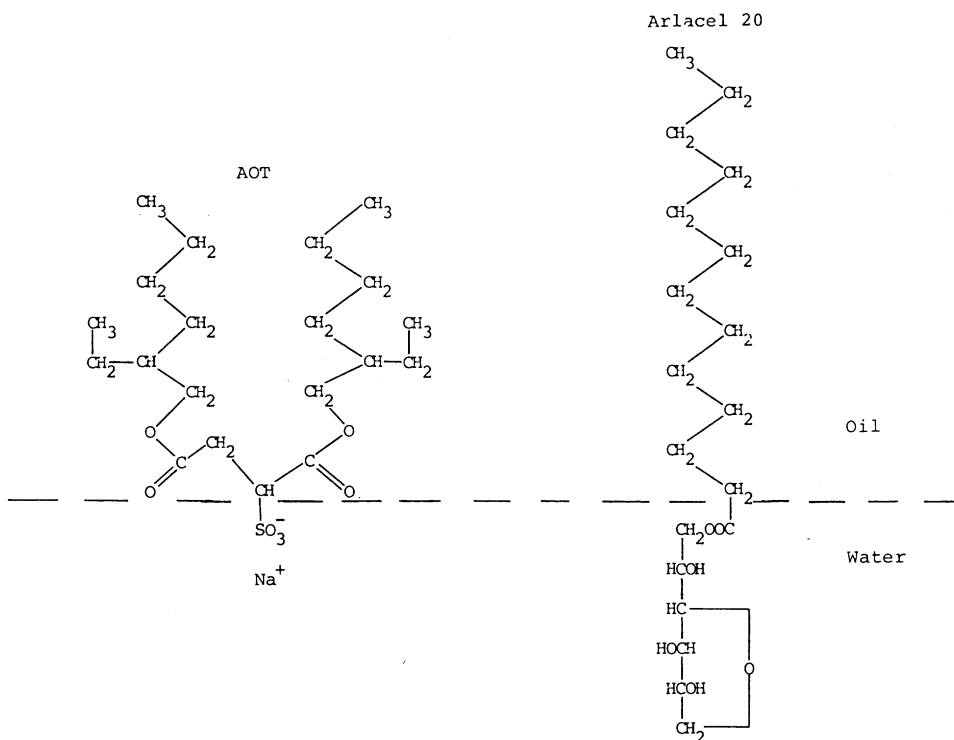

Figure 1. Molecular Structures of AOT and Arlacel 20 and their most probable orientations at the oil/water interface.

a schematic diagram showing the structures of AOT and Arlacel 20. The hydrophilic portion of AOT is a sulfonate group while Arlacel 20 has a sorbitol or sugar group. Also, the lipophilic group of AOT is branched. In contrast, the lipophilic group of Arlacel 20 is a straight chain. So, Arlacel 20 has a longer effective chain length than AOT.

Weight Ratio Effect

The effect of various weight ratios of AOT and Arlacel 20 on water solubilization in hexadecane was tested and these results are shown in Figure 2. Water solubilization peaked when the two surfactants were in a 1:1 weight ratio. Similar behavior was observed for an AOT/water/iso-octane system when certain compounds were added to the dispersion<sup>16,17</sup>. The water solubilization would increase when a specific concentration of an additive was present, and then it would begin to decrease at other con-

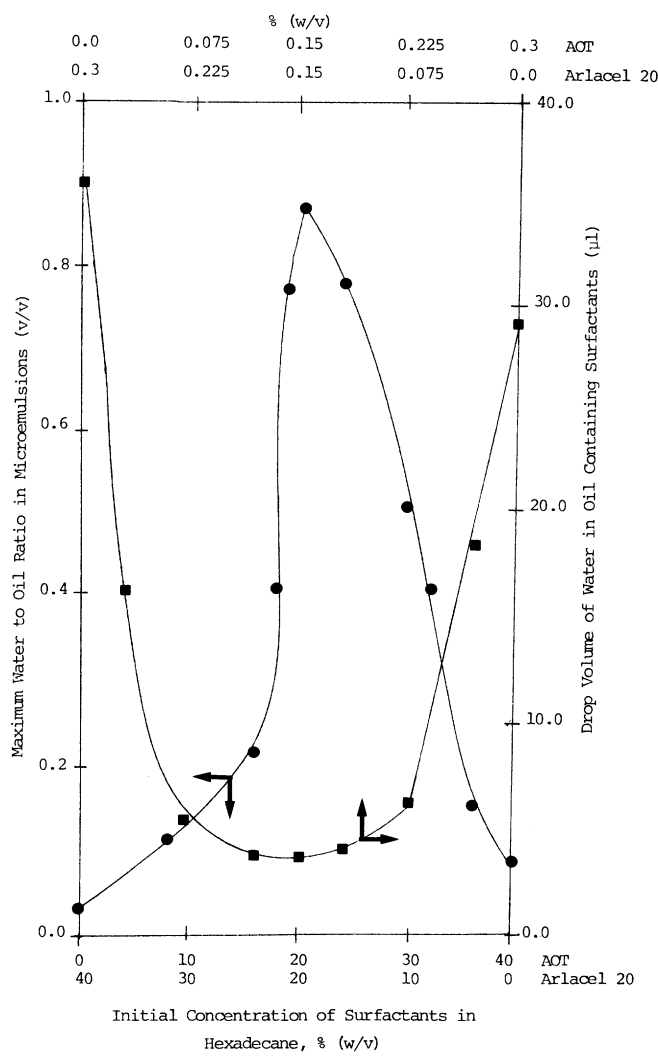

Figure 2. Effect of surfactant weight ratio on the solubilization of water and drop volume measurements in hexadecane.

centrations. It has been reported by several researchers that maximum solubility of water in an oil phase (or oil in a water phase) occurs when there is ultralow interfacial tension between the oil and water phases<sup>18-20</sup>.

Oil/water interfacial tensions for the system were measured in dilute surfactant<sup>22</sup> solutions using the drop volume method<sup>21</sup>. It has been shown by Wilkinson<sup>22</sup> that the interfacial tension,  $\gamma$ , is related to the drop volume,  $V$ , by:

$$\gamma = V\Delta\rho g/2rf \quad (1)$$

where  $\Delta\rho$  is the density difference of the two liquids,  $r$  is the radius of the syringe,  $g$  is gravitational force, and  $f$  is a correction factor. For

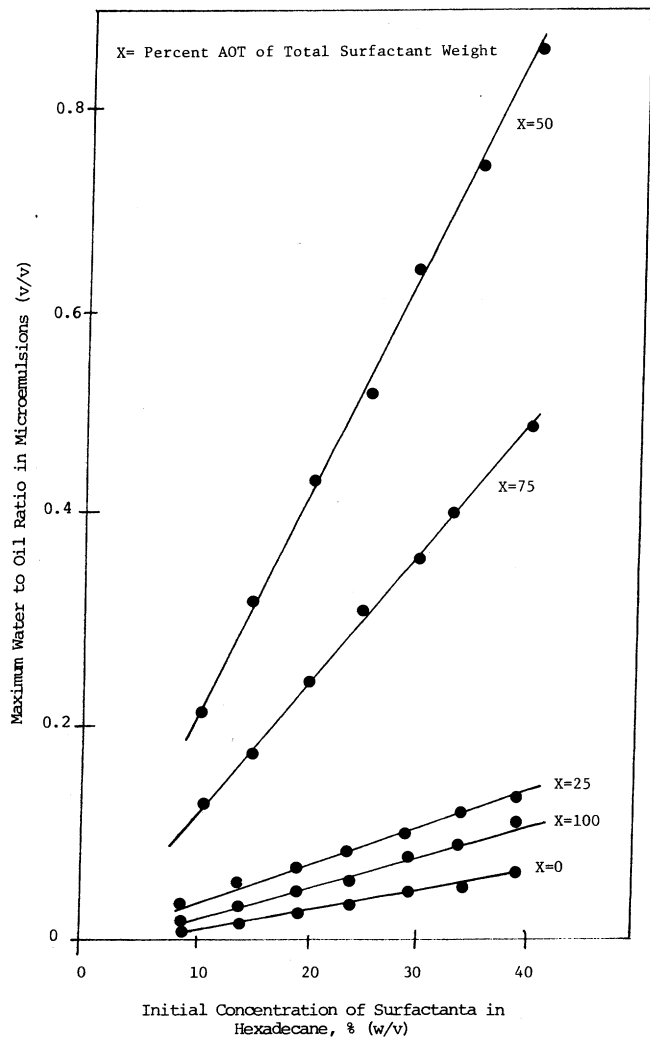

Figure 3. Effect of surfactant weight ratio on the slope and intercept for plots of the maximum solubilization of water vs. total surfactant weight for AOT and Arlace1 20 in hexadecane.

this measurement, we assume  $\Delta\rho$  to be a constant and the same syringe tip was used for each measurement. So, with all the other parameters in Equation (1) constant,  $\gamma$  is proportional to  $V$ . The results in Figure 2 show that the drop volume decreases in the region of the 1:1 weight ratio of AOT and Arlancel 20. This large decrease in the drop volume shows that

Table II. Effect of AOT/Arlancel 20 Weight Ratio on the Slope and Intercept of Plots for Solubilization of Water Versus Initial Concentration of Surfactant in Hexadecane.

% AOT of Total Surfactant Weight	Intercept on Abscissa, % (w/v)	Maximum Molar Ratio of Water to Surfactant
0	1.59	2.96
25	0.34	6.32
50	0.19	46.59
75	0.28	22.80
100	1.43	6.96

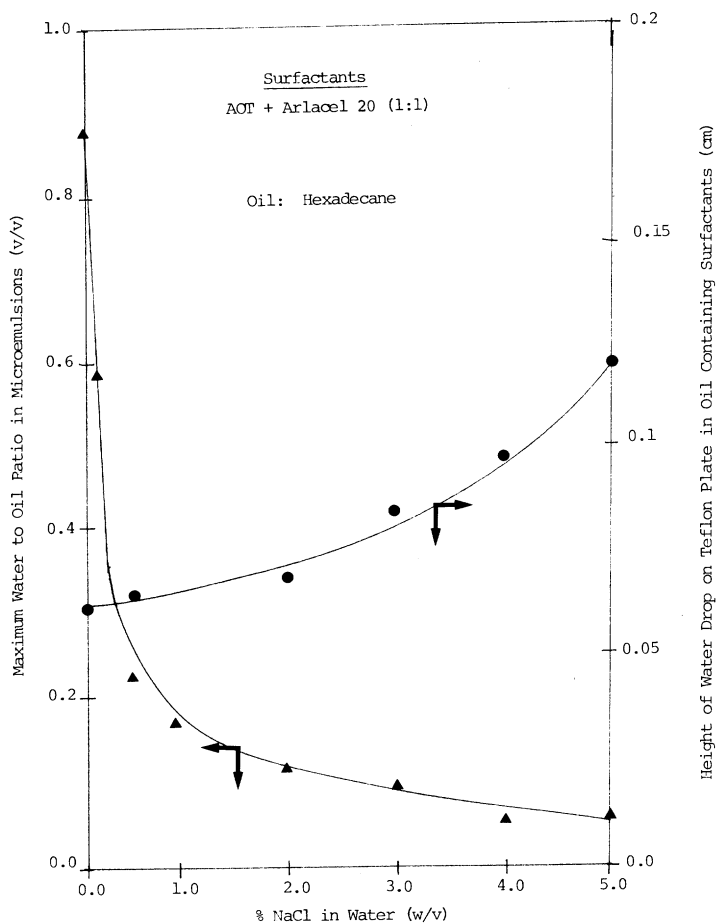

Figure 4. Effect of NaCl concentration on the maximum solubilization of water and drop volume for AOT and Arlancel 20 in hexadecane.

there is a large decrease in the oil/water interfacial tension as the 1:1 weight ratio is approached. This correlates with the solubilization data.

Figure 3 shows how the maximum solubility of water varies as the total surfactant weight changes while the weight ratio is kept constant. The slopes and intercepts for the plots are listed in Table II. As one can see, the slope, or water molecules solubilized per surfactant molecule, is highest for the 1:1 weight ratio of the two surfactants. Also, the horizontal axis intercept for the 1:1 weight ratio is closer to the origin than any other weight ratio's intercept. Bansal, Chinnaswamy, Ramachandran and Shah<sup>23</sup> have proposed that, for this type of plot, as the intercept moves farther away from the origin, the amount of surfactant at the interface decreases. These measurements also agree with the solubilization and drop volume measurements. Since there is more surfactant at the interface for the 1:1 weight ratio of AOT and Arlacel 20, the interfacial tension is lower, and the solubilization limit is higher.

### Salt Effect

The effect of NaCl concentration on the amount of water solubilized is shown in Figure 4. As the salinity of the water increased, the amount of water solubilized decreased. Since it is known that water solubility is related to interfacial tension<sup>18-20</sup>, the interfacial tension in this system must increase with an increase in salinity. The sessile drop method was used to confirm the hypothesis mentioned above. Figure 4 shows that the drop height increases as the salt concentration increases. The following equation relates the drop height to the interfacial tension<sup>24</sup>:

$$\gamma = gy^2\Delta\rho/2 \quad (2)$$

where  $g$  is gravitational force and  $y$  is the drop height. So,  $\gamma$  increases proportionally to the drop height squared times the density difference. As the salinity increases, the size of the drop and the density difference increase. Therefore, we can conclude that increasing the NaCl concentration increases the interfacial tension.

The conclusions made from the solubilization and drop height data are further confirmed by the plots in Figure 5 and by Table III. These show that as the salinity increases, the horizontal axis intercept moves farther from<sup>23</sup> the origin. This shows that there is less surfactant at the interface and, hence, smaller solubilization limit. It is also important to note that the slopes of the plots decrease with increasing salinity.

Figure 6 shows how the salinity of the water affects the maximum water solubility versus weight ratio plots. As the salinity increases, the weight ratio where the maximum water solubilization occurs shifts towards higher AOT concentrations. Furthermore, the peak water solubilization decreases. This means that more surfactant is required to solubilize the same volume of water as the salinity increases. These observations can be explained by the salting out of surfactants<sup>25</sup>.

### Viscosity Measurements and the Phase Diagram

From the initial screening tests plus the optimal weight ratio and salinity tests, an alcohol-free microemulsion was formulated with a high water to oil volume ratio using a long chain (low volatility) hydrocarbon and pharmaceutically acceptable surfactants. To determine the continuous phase, viscosity measurements were made as a function of the volume frac-

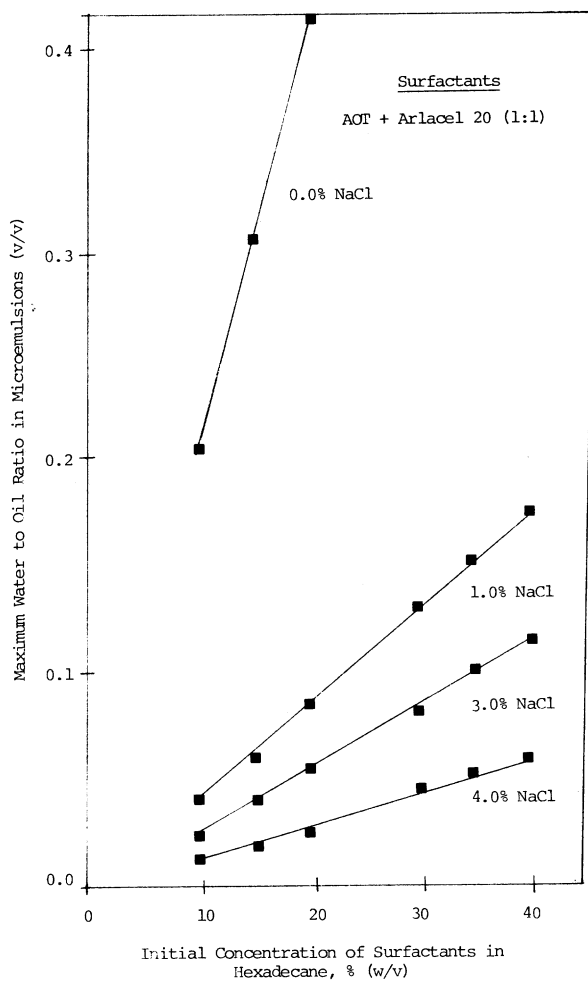

Figure 5. Effect of NaCl concentration on the slope and intercept for a plot of the maximum solubilization of water vs. total surfactant concentration for AOT and Arlancel 20 in hexadecane.

Table III. Effect of Salt Concentration on the Slope and Intercept for the Plot of Brine Solubilization Versus Initial Concentration of the Surfactants in Hexadecane.

% NaCl in Water	Intercept on Abscissa, % (w/v)	Maximum Molar Ratio of Water to Surfactant
0.0	0.19	46.59
1.0	0.21	9.60
2.0	0.25	6.46
3.0	0.35	3.24



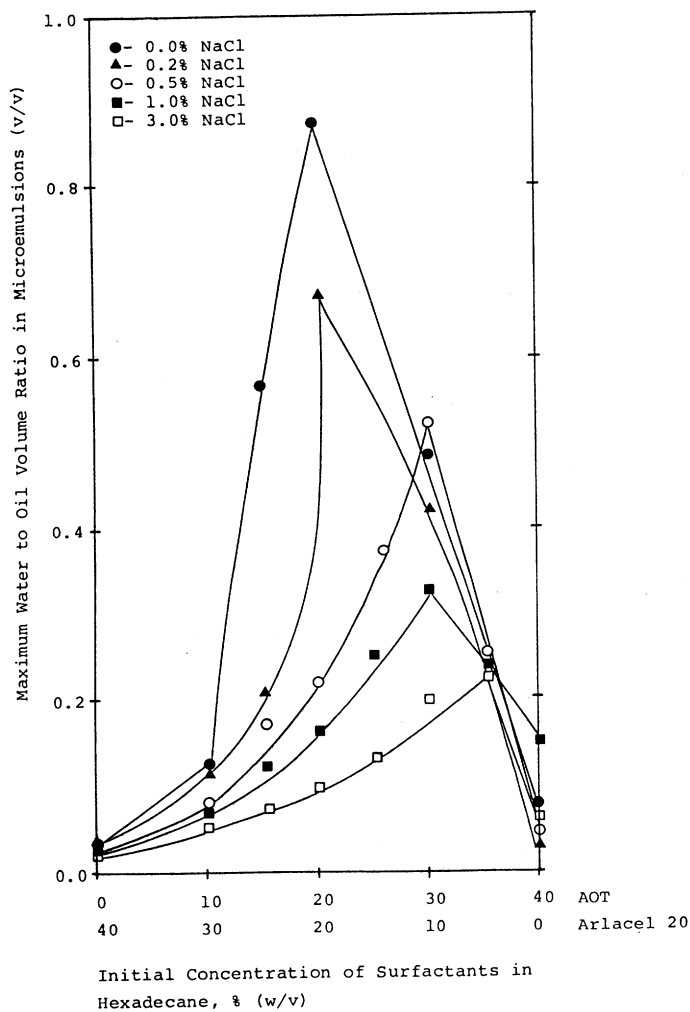

Figure 6. Effect of NaCl concentration and surfactant weight ratio on the maximum solubilization of water in hexadecane with AOT and Arlcel 20 as the surfactants.

tion of water. These measurements, plotted in Figure 7, show that the viscosity increases as the volume fraction of water increases. This demonstrates that the microemulsion formulated is of the water-in-oil type<sup>26</sup>.

The data in Figure 7 were fitted to the equation of Matsumoto and Sherman<sup>27</sup> that predicts the relative viscosity,  $\eta_r$  of a microemulsion as a function of the volume fraction of water,  $C$ , and the volume fraction of water molecularly solubilized,  $C_0$ :

$$\eta_r = (1.0 - 1.35(C - C_0))^{-2.5} \quad (3)$$

The best fit to the theoretical equation gives a  $C_0$  of 0.029. Falco *et al.* reported a  $C_0$  value of .027 for a potassium oleate system.

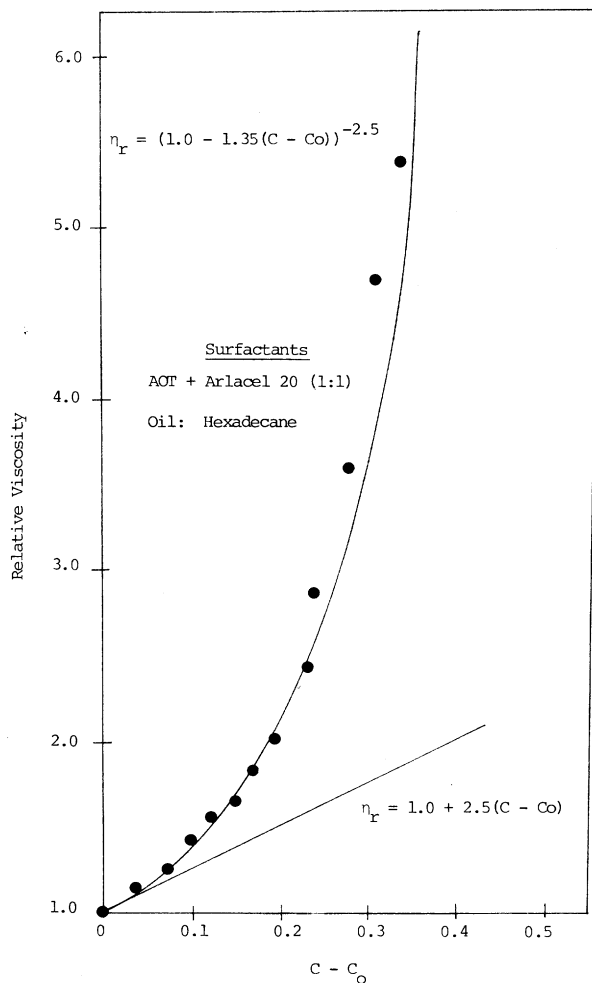

Figure 7. Effect of dispersed phase (water) concentration on the relative viscosity of the microemulsion.

Einstein's equation<sup>28</sup>:

$$\eta_r = 1.0 + 2.5(C - C_0) \quad (4)$$

is plotted in Figure 7 too. This equation is only valid for dilute solutions. One can see that this equation only fits the data at small values of  $(C - C_0)$ .

Figure 8 is the phase diagram for the hexadecane, water and surfactant (AOT and Arlachel 20, 1:1 (w/w)) system. Outside the single phase region, this system forms two or three phases. One can see that there is a large region for a single phase solution. However, this region does not extend into a portion of the phase diagram where there is a large amount

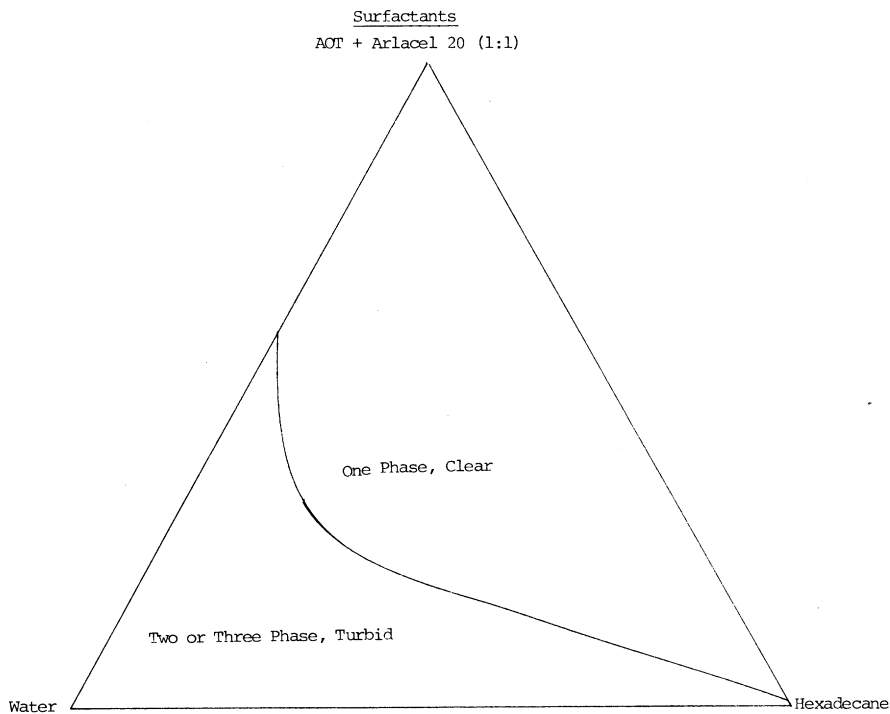

Figure 8. Phase diagram for the AOT/Arlacel 20/Hexadecane/Water system. AOT and Arlacel 20 are in a 1:1 weight ratio. All components are plotted on a weight basis.

of water. This is explained by the lower water solubilities of AOT and Arlacel 20 as compared to their solubilities in hexadecane.

#### Oil Chain Length Effect

There have been studies where a change in oil chain length, was shown to change the water solubilization capacity in reverse micelles<sup>29,30</sup>. Even though hydrocarbons with low volatility were the best for our applications, different oils were used as the continuous phase to determine the optimum ratios of AOT/Arlacel 20 surfactant combinations for maximum solubilization of water.

Figure 9 shows how the chain length of the oil used affects the solubilization of water when the surfactants are in a 1:1 weight ratio. There is a sharp increase in water solubilization between dodecane and hexadecane. A decrease in the drop volume accompanies this increase in the amount of water solubilized. The drop volume measurements are also shown in Figure 9.

It has been established that the microemulsion with the highest water solubilization in oil and the smallest drop volume or drop height has the lowest interfacial tension. Therefore, with the surfactants in a 1:1 weight ratio, the interfacial tension is lowest when hexadecane is used as

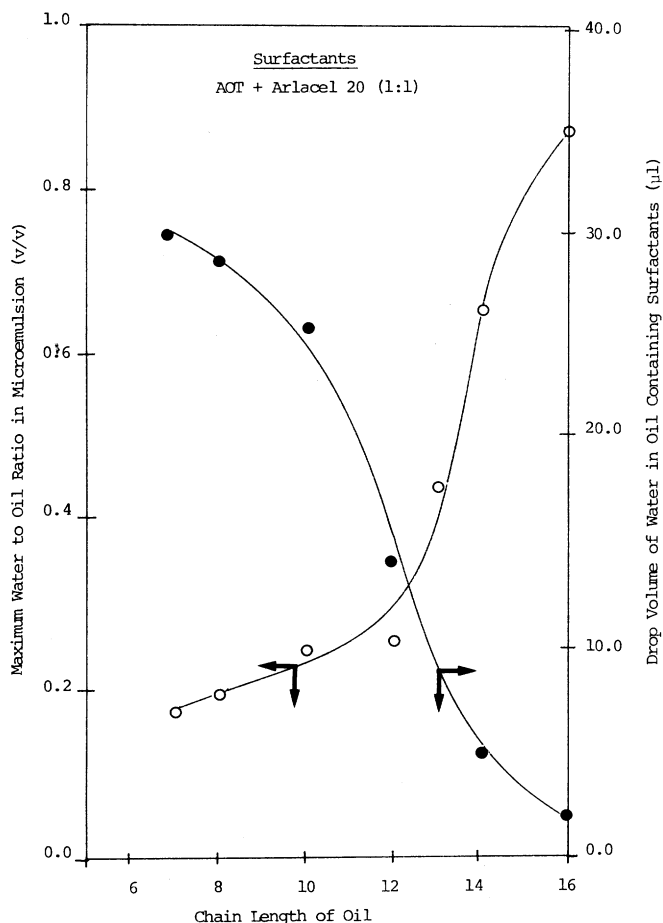

Figure 9. Effect of oil chain length on the maximum solubilization of water and drop volume of water in oil containing AOT and Arlancel 20 (1:1).

the oil. This is further confirmed by Figure 10 and Table IV. As the oil chain length is decreased and the surfactants are in a 1:1 weight ratio, the horizontal axis intercept moves farther away from the origin. So, there is less surfactant at the interface and higher interfacial tensions when the oil chain length is decreased.

As shown in Figure 11, the profile of water solubility versus weight ratio changes drastically as the oil chain length is decreased. As the oil chain length decreases, the optimal weight ratio becomes one with more AOT than Arlancel 20. Unlike the NaCl concentration effect, the solubilization maxima shifted to the left (higher Arlancel 20/AOT ratio) with longer hydrocarbon chain lengths. When heptane is the oil, maximum solubilization occurs when AOT is used alone. The water to AOT molecular ratio in heptane in Figure 11 is comparable to values reported by Fletcher et al.<sup>31</sup> They reported water to AOT molecular ratios between 40 and 70 when approaching the microemulsion phase boundary. The value from Figure 11 with AOT in heptane is 60.

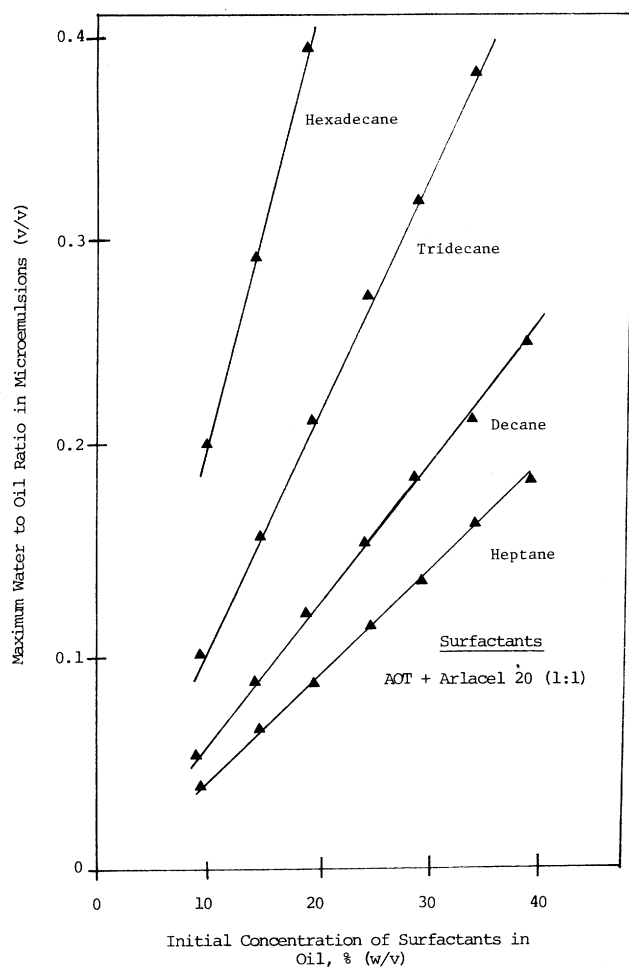

Figure 10. Effect of oil chain length on the slope and intercept for a plot of water solubility vs. surfactant concentration for AOT and Arlacel 20 in a 1:1 weight ratio.

Table IV. Effect of Oil Chain Length on the Slope and Intercept for a Plot of Water Solubilization Versus Initial Surfactant Concentration with AOT and Arlacel 20 in a 1:1 Weight Ratio.

Oil	Intercept on Abscissa, % (w/v)	Maximum Molar Ratio of Water to Surfactant
Hexadecane	0.19	46.59
Tridecane	0.25	23.55
Decane	0.32	13.42
Heptane	0.55	9.86

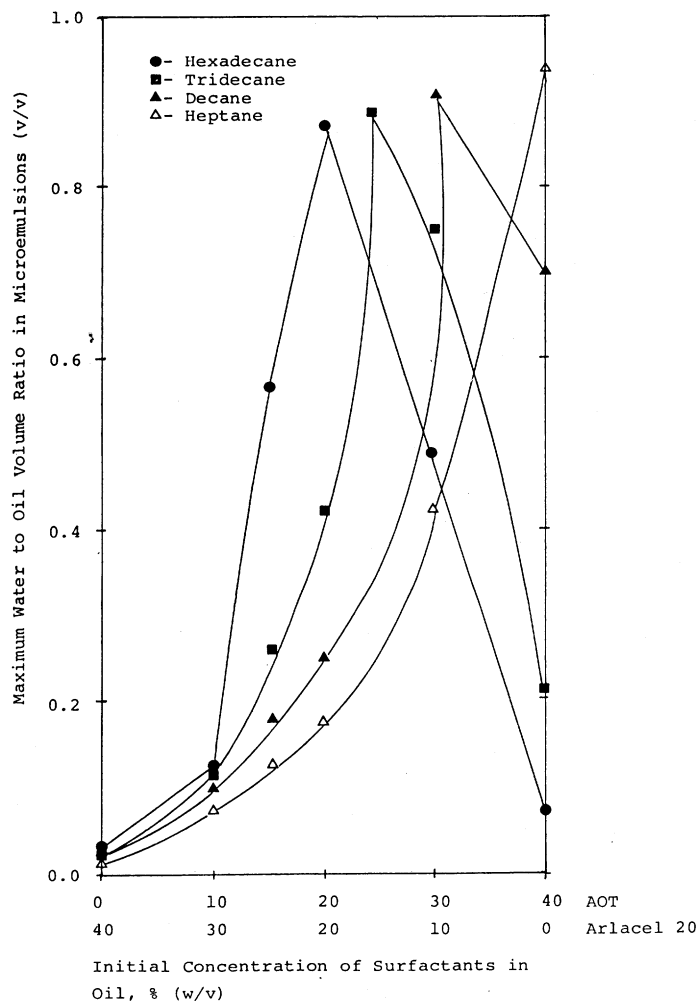

Figure 11. Effect of oil chain length and surfactant weight ratio on the maximum solubilization of water using AOT and Arlcel 20 as the surfactants.

### CONCLUSIONS

1. A water-in-oil microemulsion can be formulated by using of two high molecular weight, pharmaceutically acceptable surfactants without the use of an alcohol. Furthermore, the strategy proposed for selecting the two surfactants proved useful in reducing the the number of trials required to find the high molecular weight surfactants that could form a microemulsion.
2. The weight ratio, the salinity of the water and the oil chain length affect the maximum amount of water solubilized in a microemulsion as well as the total surfactant weight.
3. Drop volume measurements, sessile drop height measurements and extrapolated values of the amount of surfactant at the interface all correlated and showed that minimum interfacial tension occurs where water solubilization is the highest.

4. The viscosity measurements showed that only a small amount of the water was molecularly solubilized in the microemulsion. These measurements also confirmed that the microemulsion formulated was of the water-in-oil type.
5. For a given oil chain length, a specific molar ratio of the two surfactants is required for maximum water solubilization in the oil.
6. The phase diagram showed that there was a large region where clear, single phase microemulsions formed.

#### REFERENCES

1. Y. K. Pithapurwala and D. O. Shah, J. Amer. Oil Chem. Soc., 61, 1399 (1984).
2. D. O. Shah, V. K. Bansal, K. S. Chan and W. C. Hsieh, in "Improved Oil Recovery by Surfactant and Polymer Flooding," D. O. Shah and R. S. Schechter, Editors, pp. 293-337, Academic Press, New York, (1977).
3. I.A. Zlochower and J.H. Schulman, J. Colloid Interface Sci., 24, 115 (1967).
4. D.O. Shah, editor, "Surface Phenomena in Enhanced Oil Recovery," Plenum Press, New York, 1981.
5. W. B. Gogarty, J. Pet. Tech., 28, 93 (1976).
6. R. L. Reed and R. N. Healy, in "Improved Oil Recovery by Surfactant and Polymer Flooding," D. O. Shah and R. S. Schechter, Editors, pp. 383-437, Academic Press, New York, (1977).
7. M. L. Robbins, Theory of the Phase Behavior of Microemulsions, Paper No. SPE 5839, Presented at the Society of Petroleum Engineers, Tulsa, OK, (1976).
8. R. N. Healy and R. L. Reed, Soc. Pet. Eng. J., 14, 491 (1974).
9. A. Jayakrishnan, K. Kalaiarasi and D. O. Shah, J. Soc. Cosmet. Chem., 34, 334 (1983).
10. G. Gillberg, L. Eriksson and S. Friberg, in "Emulsions, Latices and Dispersions," P. Becher, Editor, pp. 210-220, Marcel Dekker, New York, (1978).
11. T. Z. Csaky and B. A. Barnea, Editors, "Cutting's Handbook of Pharmacology," p. 338, Appleton-Century-Crofts, Norwalk, CT (1984).
12. "Aerosol OT Surfactant", American Cyanamid Publication PRT 73-C, Chemical Products Division, P. O. Box 31, Linden, NJ 07036.
13. J. F. Treon, Am. Perfumer and Cosmetics, 77, 35 (1962).
14. "ICI Americas Products for Cosmetics and Pharmaceuticals," Publication # 100-2, (1977), ICI Americas Medical Research Department, Wilmington, Delaware 19897 USA.
15. "Registry of Toxic Effects of Chemical Substances," Table I, U. S. Department of Health, Education and Welfare, June 1975.

16. H. F. Eicke, *J. Colloid Interface Sci.*, 68, 440 (1979).
17. A. Maitra, G. Vasta and H. F. Eicke, *J. Colloid Interface Sci.*, 93, 383 (1983).
18. K. Shinoda and H. Saito, *J. Colloid Interface Sci.*, 26, 70 (1969).
19. K. Shinoda and H. Kunieda, in "Microemulsions, Theory and Practice," L. M. Prince, Editor, Academic Press, New York, (1977).
20. F. I. Iskanderani, Ph.D. Thesis, College of Engineering, University of Florida, 1985.
21. M. C. Wilkinson and R. L. Kidwell, *J. Colloid Interface Sci.* 35, 114 (1971).
22. M. C. Wilkinson, *J. Colloid Interface Sci.*, 40, 14 (1972).
23. V. K. Bansal, K. Chinnaswamy, C. Ramachandran and D. O. Shah, *J. Colloid Interface Sci.*, 72, 524 (1979).
24. L. I. Osipow, "Surface Chemistry," Reinhold Pub., New York, (1962).
25. E. Ruckenstein and J. A. Beunen, *J. Colloid Interface Sci.*, 98, 55 (1984).
26. J. W. Falco, R. D. Walker and D. O. Shah, *AIChE J.*, 20, 510 (1974).
27. S. Matsumoto and P. Sherman, *J. Colloid Interface Sci.*, 30, 525 (1969).
28. A. Einstein, *Ann. Physik.*, 34, 591 (1911).
29. S. G. Frank and G. Zografi, *J. Colloid Interface Sci.*, 29, 27 (1969).
30. E. Sjöblom and S. Friberg, *J. Colloid Interface Sci.*, 67, 16 (1978).
31. P. D. I. Fletcher, B. H. Robinson, F. Bermejo-Barrera, D. G. Oakenfull, J. C. Dore and D. C. Steyler, in "Microemulsions," I. D. Robb, Editor, pp. 221-231, Plenum Press, New York, (1981).